

**JBL**

NORTHRIDGE™ E SERIES

E150P, E250P

OWNER'S GUIDE

# READ FIRST!

## Important Safety Precautions!

<b>CAUTION</b>	
<b>RISK OF ELECTRIC SHOCK</b> <b>DO NOT OPEN</b>	
CAUTION: To reduce the risk of electric shock, do not remove cover (or back). No user-serviceable parts inside. Refer servicing to qualified service personnel.	
CAUTION: To prevent electric shock, do not use this (polarized) plug with an extension cord, receptacle or other outlet unless the blades can be fully inserted to prevent blade exposure.	
	The lightning flash with arrowhead symbol, within an equilateral triangle, is intended to alert the user to the presence of uninsulated "dangerous voltage" within the product's enclosure that may be of sufficient magnitude to constitute a risk of electric shock to persons.
	The exclamation point within an equilateral triangle is intended to alert the user to the presence of important operating and maintenance (servicing) instructions in the literature accompanying the appliance.

1. Read these instructions.
2. Keep these instructions.
3. Heed all warnings.
4. Follow all instructions.
5. Do not use this apparatus near water.
6. Clean only with a dry cloth.
7. Do not block any ventilation openings. Install in accordance with the manufacturer's instructions.
8. Do not install near any heat sources such as radiators, heat registers, stoves or other apparatus (including amplifiers) that produce heat.
9. Do not defeat the safety purpose of the polarized or grounding-type plug. A polarized plug has two blades with one wider than the other. A grounding-type plug has two blades and a third grounding prong. The wide blade or the third prong are provided for your safety. If the provided plug does not fit into your outlet, consult an electrician for replacement of the obsolete outlet.
10. Protect the power cord from being walked on or pinched, particularly at plugs, convenience receptacles and the point where they exit from the apparatus.
11. Only use attachments/ accessories specified by the manufacturer.
12. Use only with the cart, stand, tripod, bracket or table specified by the manufacturer or sold with the apparatus.



When a cart is used, use caution when moving the cart/apparatus combination to avoid injury from tip-over.

13. Unplug this apparatus during lightning storms or when unused for long periods of time.
14. Refer all servicing to qualified service personnel. Servicing is required when the apparatus has been damaged in any way, such as power-supply cord or plug is damaged, liquid has been spilled or objects have fallen into the apparatus, the apparatus has been exposed to rain or moisture, does not operate normally, or has been dropped.
15. Do not use attachments not recommended by the product manufacturer, as they may cause hazards.
16. This product should be operated only from the type of power source indicated on the marking label. If you are not sure of the type of power supply to your home, consult your product dealer or local power company. For products intended to operate from battery power, or other sources, refer to the operating instructions.
17. If an outside antenna or cable system is connected to the product, be sure the antenna or cable system is grounded so as to provide some protection against voltage surges and built-up static charges. Article 810 of the National Electrical Code, ANSI/NFPA 70, provides information with regard to proper grounding of the mast and supporting structure, grounding of the lead-in wire to an antenna discharge unit, size of grounding conductors, location of antenna-discharge unit, connection to grounding electrodes, and

requirements for the grounding electrode. See Figure A.

18. An outside antenna system should not be located in the vicinity of overhead power lines or other electric light or power circuits, or where it can fall into such power lines or circuits. When installing an outside antenna system, extreme care should be taken to keep from touching such power lines or circuits, as contact with them might be fatal.
19. Do not overload wall outlets, extension cords, or integral convenience receptacles, as this can result in a risk of fire or electric shock.
20. Never push objects of any kind into this product through openings, as they may touch dangerous voltage points or short-out parts that could result in a fire or electric shock. Never spill liquid of any kind on the product.
21. Do not attempt to service this product yourself, as opening or removing covers may expose you to dangerous voltage or other hazards. Refer all servicing to qualified service personnel.
22. When replacement parts are required, be sure the service technician has used replacement parts specified by the manufacturer or that have the same characteristics as the original part. Unauthorized substitutions may result in fire, electric shock or other hazards.
23. Upon completion of any service or repairs to this product, ask the service technician to perform safety checks to determine that the product is in proper operating condition.
24. The product should be mounted to a wall or ceiling only as recommended by the manufacturer.

Figure A.  
Example of Antenna Grounding as per National Electrical Code, ANSI/NFPA 70

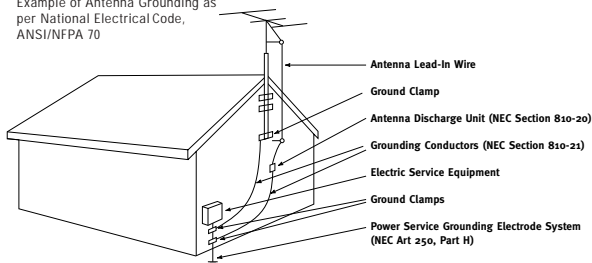

# THANK YOU FOR CHOOSING JBL

For more than 50 years, JBL has been involved in every aspect of music and film recording and reproduction, from live performances to the recordings you play in your home, car or office.

We're confident that the JBL system you have chosen will

provide every note of enjoyment that you expected – and that when you think about purchasing additional audio equipment for your home, car or office, you will once again choose JBL.

Please take a moment to register your product on our

Web site at [www.jbl.com](http://www.jbl.com).

This enables us to keep you posted on our latest advancements, and helps us to better understand our customers and build products that meet their needs and expectations.

*JBL Consumer Products*

## SPEAKER PLACEMENT

- **As a general rule, bass response increases as a subwoofer is placed closer to a wall. Therefore, bass output is maximized when the subwoofer is placed in a corner.**
- **It is also recommended that the subwoofer be positioned along the same wall as the front loudspeakers.**

Low-frequency sounds are normally omnidirectional, meaning the listener can't tell where they are generated from. However, frequencies between 75Hz and 150Hz can be localized, especially at higher volume levels. Positioning your subwoofer as recommended will provide the most natural soundstage and imaging from your loudspeaker system.

Remember that these are just guidelines. Since every listening room is different, JBL strongly

recommends experimenting with the positioning of your subwoofer to obtain the most pleasing results in your room. One technique that can help you find the ideal subwoofer location is to temporarily place the subwoofer near the main listening location. Then move around the room and determine where you hear the most pleasing bass performance. This would then be the ideal location for the subwoofer.

## SPEAKER CONNECTION

When we designed the E150P and E250P powered subwoofers, our goal was to offer the user the best possible performance combined with the most flexible and complete installation options. Please look over the following three examples to determine which description best matches your system and follow the corresponding hookup instructions.

To use the binding-post speaker terminals with bare wire, unscrew the collar until the hole through the center post is visible under the collar. Insert the bare end of the wire

through the hole in the post, then screw the collar back down until the connection is tight. The holes in the center of the collars are intended for banana-type connectors.

Speakers and electronics terminals have corresponding positive (+) and negative (-) terminals. It is important to connect both speakers identically: positive (+) on the speaker to positive (+) on the amplifier and negative (-) on the speaker to negative (-) on the amplifier. Wiring "out of phase" results in thin sound, weak bass and a poor stereo image.

**NOTE:** The speaker-level connection method described on page 4 is not a preferred connection and should only be resorted to if your receiver/processor does not have a line-level or subwoofer output. The customer is responsible for proper connections, and any damage to JBL or other equipment due to improper connections will not be covered by your JBL warranty. Consult with your JBL dealer or an audio-installation expert if you have any questions about how to connect your subwoofer using the speaker-level inputs.

# Analog Receiver/Processor – Speaker-Level Connections

Use this installation method *only* with an analog receiver/processor that does not have digital processing or bass management, and also does not have a subwoofer output or a volume-controlled preamp (line-) level output:

Connect the speaker wires for both your main left and right speakers, and for the subwoofer, to the same speaker terminals on your receiver or amplifier. The wires may be joined by twisting together the bare ends of the two leads that will be connected to each terminal on the receiver/amplifier, as shown in the diagram. This procedure should be done only four times (involving a total of eight bare-wire ends), and only for those wire ends that are being connected to the terminals on your receiver/amplifier. ***It is important that you avoid joining any other wires.*** Do not twist together wire ends that are being inserted into terminals on any speaker or on the subwoofer. Do not twist together wire ends that will be used for any speakers other than the front left and right speakers or the subwoofer. Refer to the connection diagram for guidance.

Twist together the (+) leads at one end of the speaker wires that you have designated for the left front speaker and for

the left high-level inputs on the subwoofer. Insert the joined (twisted) wires into the left front (+) terminal on your receiver/amplifier. Connect the free end of the (+) lead for the left front speaker to the (+) terminal on the back of the speaker. Connect the free end of the (+) lead for the left input on the subwoofer to the left binding-post terminal. Repeat this process for the (-) connections for the left front

speaker and left input on the subwoofer, and then for the (+) and (-) connections for the right front speaker and right high-level inputs on the subwoofer.

Connect your receiver or amplifier's center and surround speaker terminals to the corresponding terminals on the back of your center and surround speakers.

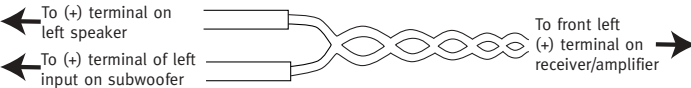
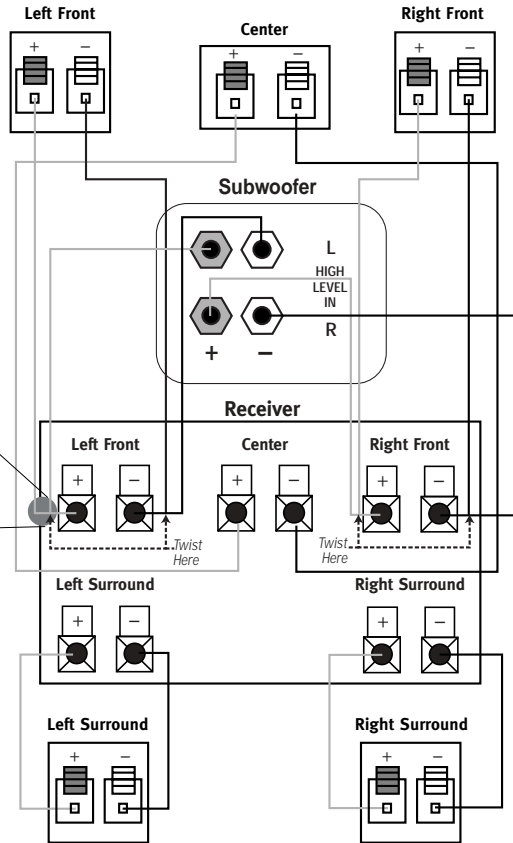
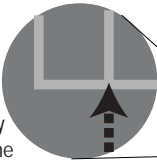

## Analog Receiver/Processor – Line-Level Connections

Use this installation method with an analog receiver/processor that does not have digital processing or bass management, and that is equipped with a full-range subwoofer output or a volume-controlled preamp (line-) level output:

Use RCA-type interconnect cables to connect the line-level subwoofer outputs on your receiver or amplifier to the line-level inputs on the subwoofer.

**IMPORTANT:** Make sure that the LFE toggle switch on the subwoofer is in the “Normal” position. Do not use the “LFE” position with Dolby\* Pro Logic\*-only processors.

Note: If your receiver or amplifier has only one subwoofer output jack, then you

may connect the subwoofer output on your receiver/pre-amplifier to either the left or right line-level input on the subwoofer. It makes no difference which jack you choose.

Connect each speaker to the corresponding speaker terminals on your receiver or amplifier.

Make sure your receiver or processor is configured so that the subwoofer is “On.”

Note for advanced users: If your receiver/processor has a built-in low-pass crossover filter for the subwoofer output, then the LFE switch should be set to the “LFE” position to bypass the subwoofer’s internal crossover.

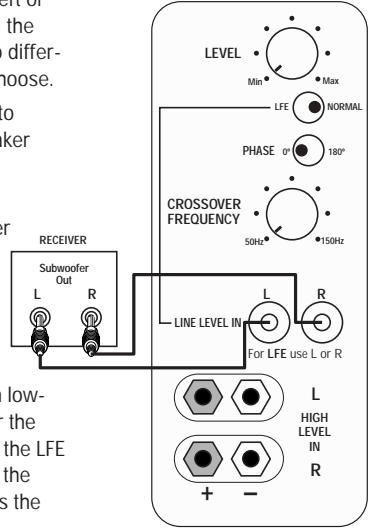

## Digital Receiver/Processor – LFE Connection

Use this installation method for Dolby Digital, DTS® or other digital surround processors that have bass-management programming, or for analog receivers/processors that have a filtered subwoofer output:

**IMPORTANT:** Make sure that the LFE toggle switch on the subwoofer is in the “LFE” position. Use the line-level input jacks for the Low-Frequency Effects channel. Connect these jacks to the LFE output or subwoofer output on your receiver or amplifier.

Note: If your receiver or amplifier has only one subwoofer output jack, you may connect the subwoofer output on your receiver/pre-amplifier to either

the left or right line-level input on the subwoofer. It makes no difference which jack you choose.

Connect each speaker to the corresponding speaker terminals on your receiver or amplifier.

Make sure that you have configured your surround sound processor for “Subwoofer On” or “LFE On.” The front, center and surround speakers should be set to “Small” or “Large” depending on their size and frequency response. Consult your receiver’s or processor’s owner’s manual.

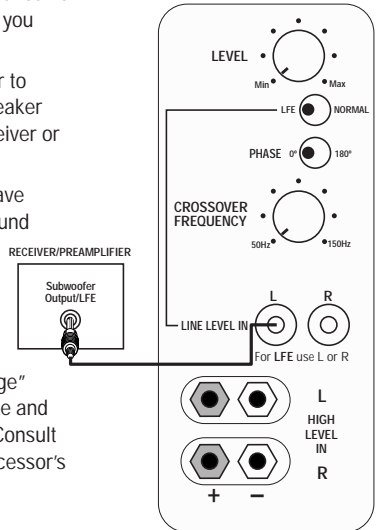

# OPERATION

## Power

When the unit is plugged in and the power switch is on and no signal is received, the LED on the top of the unit will turn red. When a signal is present, the LED will turn green.

Note: It will take several minutes for the LED to turn from green to red after the input signal to the subwoofer is removed. Due to JBL's unique high-output, high-efficiency amplifier design, power consumption is minimal when the subwoofer is not receiving a signal. Of course, the subwoofer can be turned off, whenever desired, if you do not wish to leave it in auto (standby) mode.

sumption is minimal when the subwoofer is not receiving a signal. Of course, the subwoofer can be turned off, whenever desired, if you do not wish to leave it in auto (standby) mode.

## Level Control

The subwoofer Level Control adjusts the volume of the subwoofer relative to the rest of the system. Proper level adjustment depends on several variables such as room

size, subwoofer placement, type of main speakers and position. Adjust the subwoofer level so that the volume of the bass information is pleasing to you.

## Crossover Adjustments

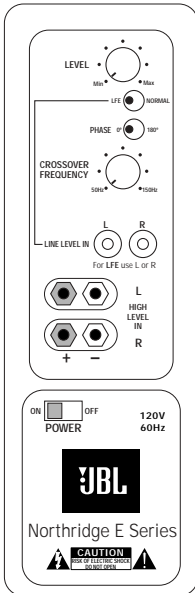

The Crossover Frequency Control determines the highest frequency at which the subwoofer reproduces sounds. If your main speakers can comfortably reproduce some low-frequency sounds, set this control to a lower frequency setting, between 50Hz and 100Hz. This will concentrate the subwoofer's efforts on the ultradeep bass sounds required by today's films and music. If you are using smaller bookshelf speakers that do not extend to the lower bass frequencies, set the low-pass crossover control to a higher setting, between 120Hz and 150Hz. This control is not used when the LFE switch is in the "LFE" position.

## Phase Control



The Phase Control determines whether the subwoofer's piston-like action moves in and out in phase with the main speakers or opposite the main speakers. There is no correct or incorrect setting. Proper phase adjustment depends on several variables such as subwoofer placement and listener position. Adjust the phase switch to maximize

bass output at the listening position.

Remember, every system, room and listener is different. There are no right or wrong settings; this switch offers the added flexibility to adjust your subwoofer for optimum performance for your specific listening conditions without having to move your speakers.

If at some time in the future you happen to rearrange your listening room and move your speakers, you should experiment with the phase switch in both positions, and leave it in the position that maximizes bass performance.

## TROUBLESHOOTING

**If you used the high-level (speaker) inputs and there is no sound from any of the speakers:**

- Check that the receiver/amplifier is on and a source is playing.
- Check that the powered subwoofer is plugged into an active electrical outlet and is switched on.
- Check all wires and connections between the receiver/amplifier and the speakers. Make sure all wires are connected. Make sure none of the speaker wires are frayed, cut or punctured, or touching each other, except for the wires for the front left and right speakers, which may be joined with the wires for the subwoofer at the receiver/amplifier end only, if you are using the speaker-level connections as described on page 4.
- Review proper operation of your receiver/amplifier.

**If there is low (or no) bass output:**

- Make sure the connections to the left and right "Speaker Inputs" have the correct polarity (+ and -).
- Make sure that the subwoofer is plugged into an active electrical outlet and switched on.
- Adjust the crossover point.
- Flip the Phase Control switch to the opposite position.
- If you are using a Dolby Digital/DTS receiver or processor, make sure that the subwoofer adjustments on the receiver/processor are set up correctly.
- Slowly turn the Level Control clockwise until you begin to hear the desired amount of bass.

**If you used the line-level inputs and there is no sound from the subwoofer:**

- Check that the receiver/amplifier is on and a source is playing.
- Check that the powered subwoofer is plugged into an active electrical outlet and is switched on.
- Check all wires and connections between the receiver/amplifier and the subwoofer. Make sure all wires are connected. Make sure none of the wires are frayed, cut or punctured, or touching each other.
- Review proper operation of your receiver/amplifier.
- Slowly turn the Level Control clockwise until you begin to hear the desired amount of bass.
- Make sure that you have configured your receiver/processor so that the subwoofer/LFE output is on.

# SPECIFICATIONS

	<b>E150P</b>	<b>E250P</b>
<b>Amplifier Power (RMS):</b>	150 Watts	250 Watts
<b>Peak Dynamic Power†:</b>	250 Watts	550 Watts
<b>Driver:</b>	10" PolyPlas™	12" PolyPlas™
<b>Inputs:</b>	Line Level (switchable to LFE) and Speaker Level with 5-way binding posts	Line Level (switchable to LFE) and Speaker Level with 5-way binding posts
<b>Low-Pass Frequency:</b>	Variable from 50Hz to 150Hz	Variable from 50Hz to 150Hz
<b>Frequency Response:</b>	27Hz – Low-pass crossover setting	25Hz – Low-pass crossover setting
<b>Dimensions (H x W x D):</b>	17-3/4" x 12-1/4" x 14-1/2" (451mm x 311mm x 368mm)	19-3/4" x 14-3/8" x 16-1/2" (502mm x 365mm x 419mm)
<b>Weight:</b>	33.5 lb/15.2kg	43 lb/19.5kg

† The Peak Dynamic Power is measured by recording the highest center-to-peak voltage measured across the output of a resistive load equal to minimum impedance of the transducer, using a 50Hz sine wave burst, 3 cycles on, 17 cycles off.

<b>JBL</b>	<b>PRO SOUND COMES HOME™</b>
JBL Consumer Products, 250 Crossways Park Drive, Woodbury, NY 11797 8500 Balboa Boulevard, Northridge, CA 91329 www.jbl.com	
© 2003 Harman International Industries, Incorporated	
JBL is a registered trademark of Harman International Industries, Incorporated.	
<b>H</b> A Harman International Company	Part No. 350883-001

\* Trademarks of Dolby Laboratories.

DTS is a registered trademark of Digital Theater Systems, Inc.

All features and specifications are subject to change without notice.